

1. Unpack and check the luminaire and accessories.
Wear work Gloves to keep the light clean, avoiding any oil or dirt transferred to it.

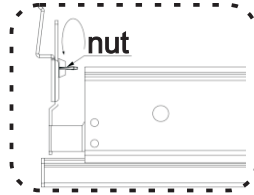

Figure1

2. Turn off the main power.

3. Unlock the two nuts at the ends of the linear light (Figure1).

4. Install the linear light to ceiling grid and tighten the two terminal nuts. (Figure2 and Figure3)

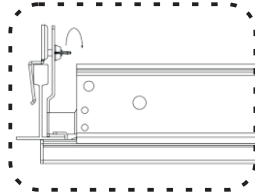

Figure2

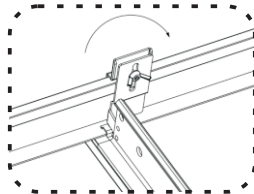

Figure3

5. Unlock the nuts from both end of the Junction box (Figure4).

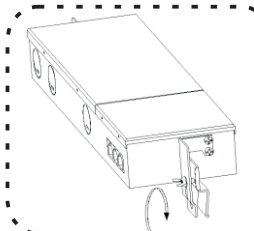

Figure4

6. Secure the junction box to the linear light and tighten the two terminal nuts. (Figure5 and Figure6)

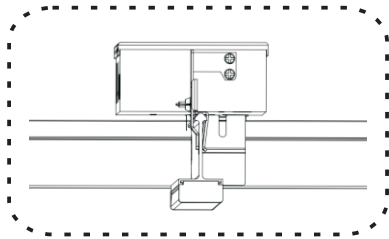

Figure5

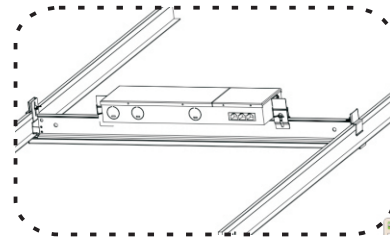

Figure6

7. Connect the connector (RJ45) from the LED Lighting unit to the output connector of the Junction Box. (Figure7)
Please note one drive can only support max 3 units. (Figure8)

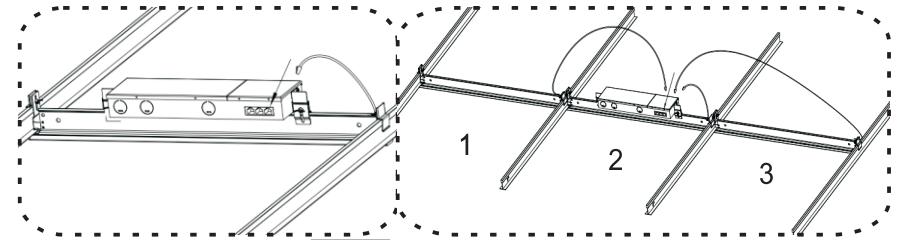

Figure7

Figure8

8. Open the Junction Box, connect the L (Live), N (Neutral), G (Ground) wires by using the 4-pin connector and connect the dimming wire with the orange connector cap.

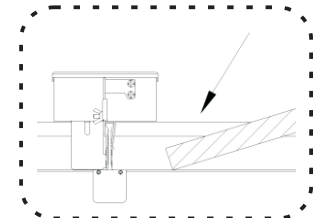
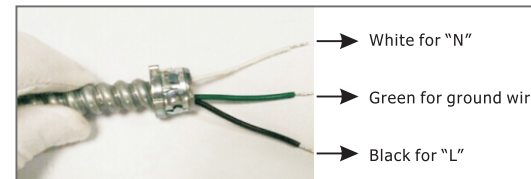

Figure9

9. Cover the plasterboard to finish installation and ensure there is no gap at ceiling. (Figure9 and Figure10)

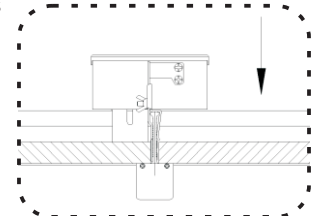
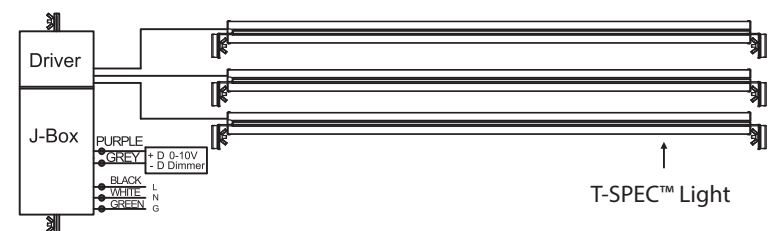

Figure10

Wiring Diagram



- Remove the related T-grid for the drop ceiling according to the shape design.
For example, for "□" shape remove the No.1, No.2, No.3, No.4, No.5 and No.6 T-grid;
for "+" shape, remove the No.5, No.6, No.7 and No.8 T-grid:
Note: The adjacent T-grid must be fixed by the pendant; Warning do not replace the main-tee. (Figure1)

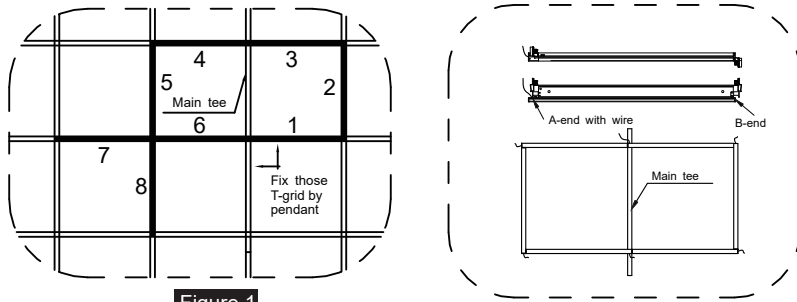
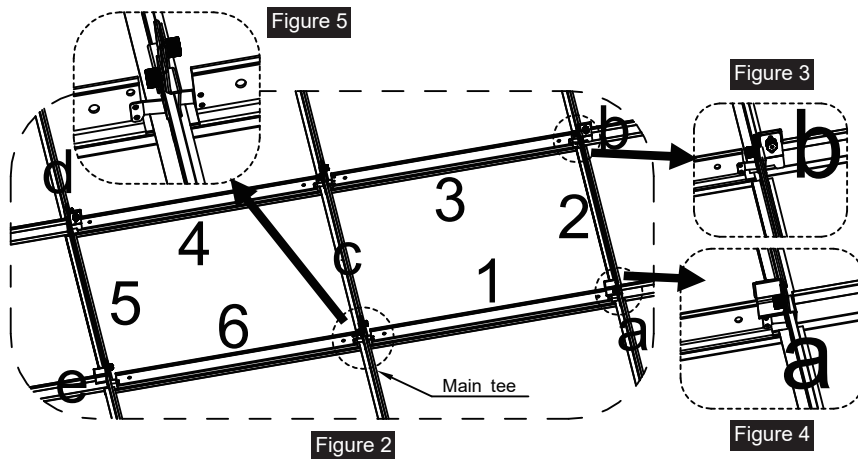

Figure 1

- The "□" shape installation steps:
Step1, for No.1 light fixture, attach the A- end with wire of the No.1 light fixture by pendant and B-end on the "a" T-grid.
Step2, attach the No.2 light fixture on the No.1 light fixture with the A-end with wire and the B-end on the "b" T-grid.
Step3, attach the No.3 light fixture on the No.2 light fixture with the A-end with wire and the B-end on the "c" T-grid.
Step4, attach the No.4 light fixture on the "c" T-grid with the A-end with wire and the B-end on the "d" T-grid.
Step5, attach the No.5 light fixture on the No.4 light fixture with the A-end with wire and the B-end on the "e" T-grid.
Step6, attach the No.6 light fixture on the No.5 light fixture with the A-end with wire and the B-end on the "c" T-grid.
(Figure2, Figure3, Figure4, Figure5)



- The "T" shape installation steps:
Firstly, install the no.5 light fixture, attach the A-end with wire of the light fixture on the "d" T-grid and the B-end by pendant;
Secondly, attach the A-end with the wire of the No.6 light fixture on the No.5 light fixture and the B-end of the fixture on the "e" T-grid .
Using the same method the A-end with wire of the No.7 light fixture on the "g" T-grid, and the B-end on the "f" T-grid.

- The "+" shape installation steps:
Follow the "T" shape installation steps and replace the "f" T-grid with one light fixture.
(Figure 6, Figure 7, and Figure 8)

