

WARNING

PLEASE READ ALL INSTRUCTIONS BEFORE ATTEMPTING INSTALLATION

- To prevent personal injury or product damage only licensed electricians should install.
- To avoid electric shock or component damage disconnect power before attempting installation or servicing.
- This product must be installed in accordance with the national electric code (NEC) and all applicable federal, state and local electric codes and safety standards.
- Disconnect product and allow cooling prior to servicing.
- Any alteration or modification of this product is expressly forbidden as it may cause serious personal injury, death, property damage and/or product malfunction.
- To prevent product malfunction and/or electrical shock this product must be properly grounded.
- This product must be installed in accordance with application installation code by a person familiar with the construction and operation of the product and the hazards involved.
- Constant current can be achieved by 0-10VDC Dimming.

Installation

Wiring Diagram

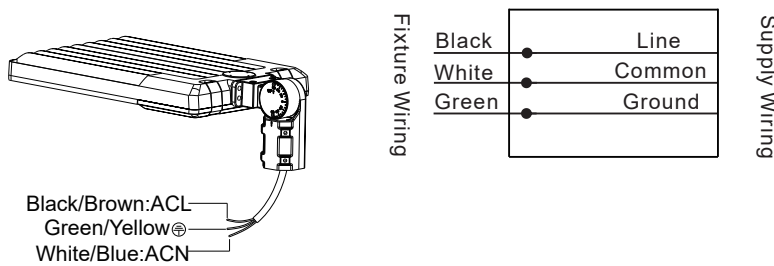

Adjustable Pole Mount [Round & Square Pole]

- Step 1: Attach adjustable pole mount bracket to square pole with bolt. (Figure 1)
 Step 2: Feed supply wires from inside the pole through the mounting bracket base. Put the connected wire into Pole, connect the wire properly and cover the junction box. (Figure 2) Notice: Adjustable angle is 0-35°(Figure 1).
 Same as round pole installation, please remember to remove the silicon plate when install the fixture in round pole(Figure 3)

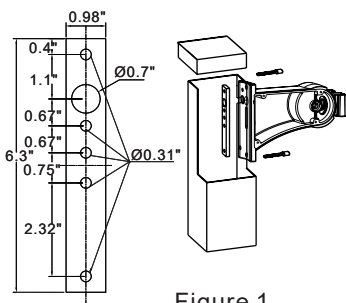

Figure 1

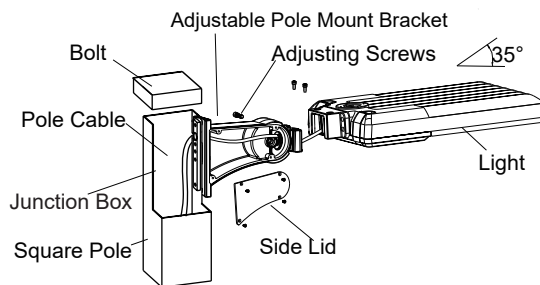

Figure 2

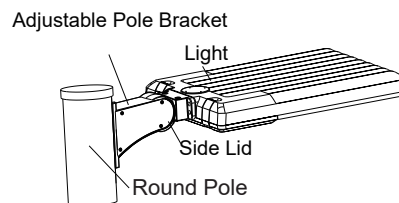
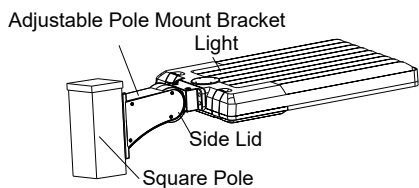
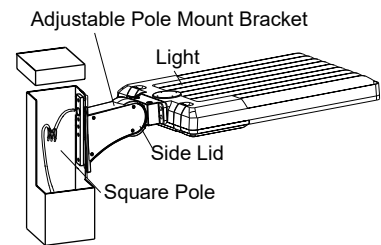

Figure 3

Fixed Pole Mount [Round & Square Pole]

Step 1: Attach fixed arm mount bracket to square pole with bolt.(Figure 7)

Step 2: Feed supply wires from inside the pole through the mounting bracket base. Put the connected wire into Pole, connect the wire properly and cover the junction box. (Figure 8) Same as round pole installation, please remember to use the adapting plate for round pole installation. (Figure 9)

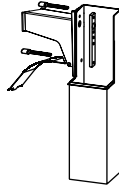
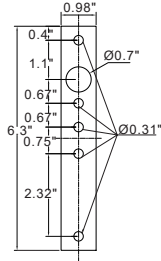

Figure 7

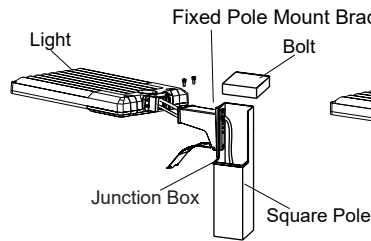

Figure 8

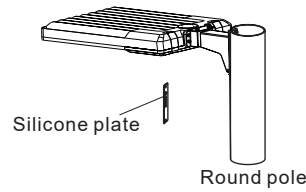
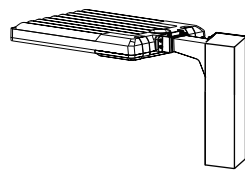
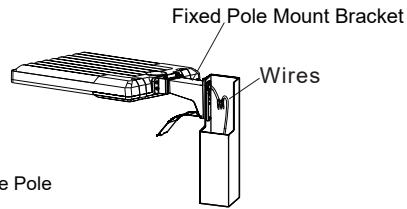

Figure 9

Slipfitter

Step 1: Open the small round cap on the bracket and run the wires through the bracket. (Figure 10)

Step 2: Install the bracket on the fixture and fix the small round cap on the bracket. (Figure 11) Step 3: Loosen the four bolts on AM2 bracket, connect the wires correctly, and pull the wires into the poles.(Figure 12)

Step 4: Place the bracket into the pole and lock the four bolts.(Figure 13)

Notice: Adjustable angle is 0-90°(Figure 12)

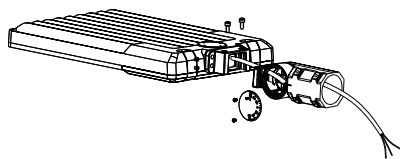

Figure 10

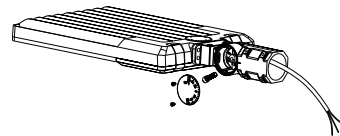

Figure 11

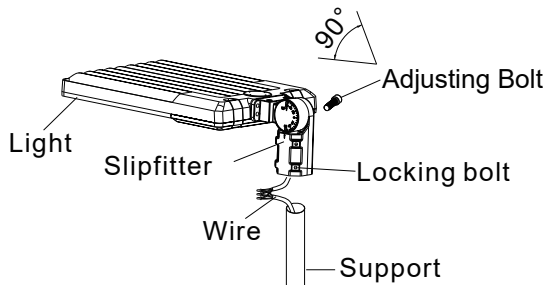
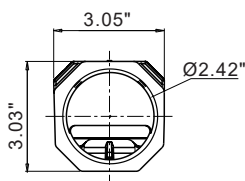

Figure 12

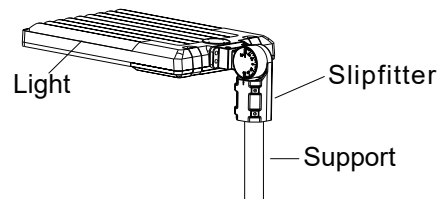

Figure 13

Trunnion

- Step 1: Drill holes into the wall as shown. (Figure 4)
 - Step 2: Knock the expansion bolt into the wall and fix the DM4 bracket on the wall with the bolt. (Figure 5)
 - Step 3: Connect the fixture to the bracket and tighten the screws; Connect the wires correctly. (Figure 6)
- Note: Adjustable Angle 0-90°(Figure 6)

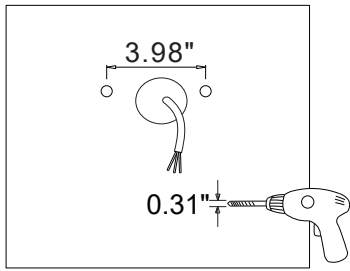

Figure 4

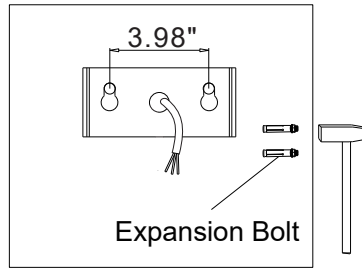

Figure 5

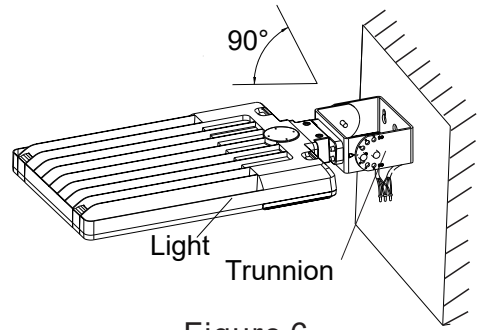
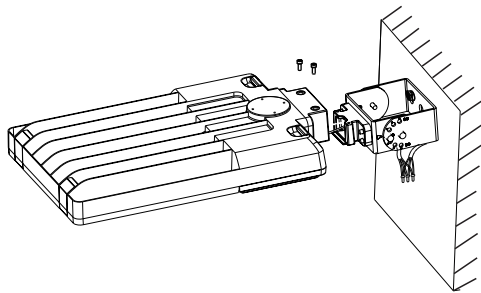
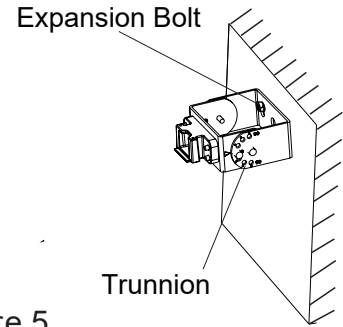
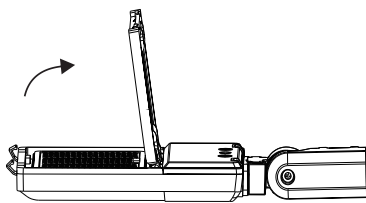

Figure 6

Tool-less Lens Swap

- 1. After taking out the fixture, first open the spring buckle, then open the lens surface frame(Figure 22), and remove the lens from the fixture(Figure 23).
- 2.Install the lens to be replaced on the lixture(Figure 24), reinstall the lens surface frame and fasten the spring buckle to complete the replacement of the required lens(Figure 25).



(Figure 22)

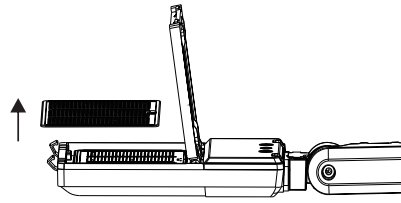

(Figure 23)

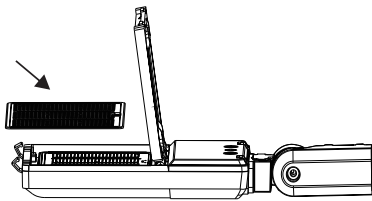

(Figure 24)

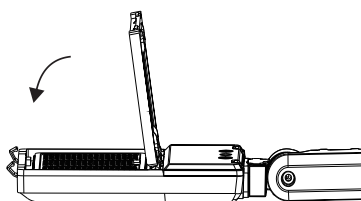

(Figure 25)

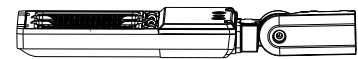

Reversible Light Shield

1. Place the light shield on the light surface so that the mounting hole of the lampshade is aligned with the screw hole of the light to block forward lighting. (Figure 26). Fasten the light shield with screws (Figure 27).

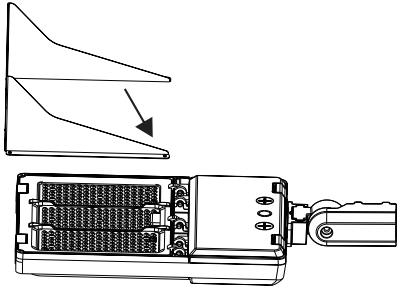

(Figure 26)

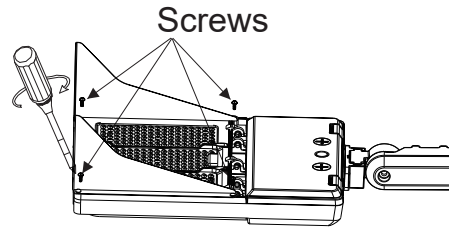

(Figure 27)

2. Place the light shield on the light face so that the mounting holes of the lampshade line up with the screw holes of the light to block back lighting. (Figure 28). Fasten the light shield with screws (Figure 29).

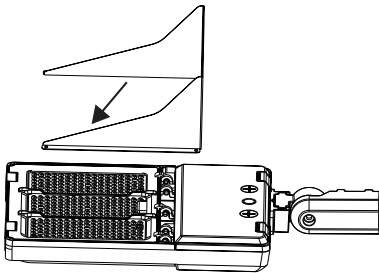

(Figure 28)

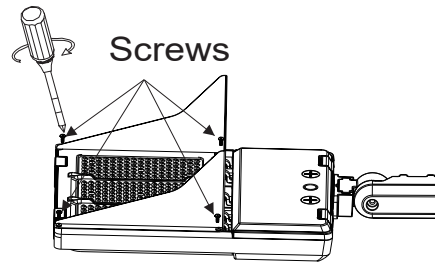

(Figure 29)

3. Place the light shield on the light face so that the mounting holes of the lampshade line up with the screw holes of the light to forward lighting and block back lighting. (Figure 30) Fasten the light shield with screws (Figure 31).

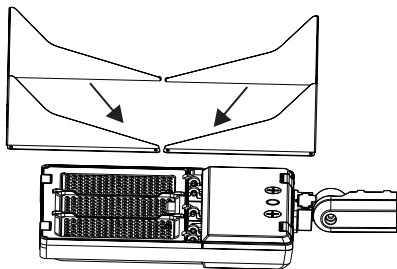

(Figure 30)

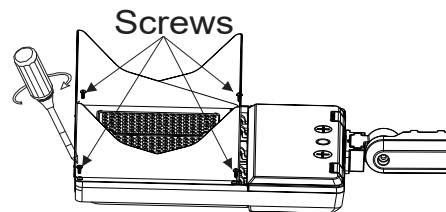

(Figure 31)

Wattage and CCT Selectable

Step 1: Open the metal plug and plastic plug counterclockwise with a screwdriver, then slide the switch up and down to adjust the power controller, CCT controller to your desired settings (Figure 20) .

Step 2: After adjusting the required control function, tighten the metal plug and the plastic plug clockwise (Figure 21) .

