



COMBINED FAMILY SPECIFICATION

ALP E2™ SP

Adjustable Area & Site Light - Stocking Package

ALP E2™ SP S - Small Adjustable Area & Site Light

ALP E2™ SP M - Medium Adjustable Area & Site Light

Straight Round & Square Steel Poles

Adapters & Brackets

| | |
|---------------|--|
| Date: | |
| Project Name: | |
| SKU #: | |

ALP E2™ SP S

Adjustable Area & Site Light - Stocking Package



INCLUDED WITH ALP™ E2 IN STOCKING PACKAGE



Three Optic Lenses Included in Box:
Type III (Installed)
Type IV & Type V

APPLICATIONS

Commercial Parking Lots, Pedestrian Pathways, Street Lighting, Site and Recreational Sports

FEATURES

Construction

- Rugged Die-cast Aluminum Housing

Electrical & Technical

- Input Voltage: 120-277V
- Input Frequency: 50/60Hz
- Projected Life: L70 > 100,000 hrs
- PF: >0.9
- CRI: >80
- THD: <20%
- Adjustable Lumen Output
- CCT Selectable: 3000K/4000K/5000K
- Operating Temp.: -40°F ~ 113°F
- IP Rating: IP65 Fixture Enclosure
- IP Rating: IK08
- Surge Protection: 10kV [Included]
- AUX Power 12V [Included]

Controls

- 0-10V Dimming [Standard]
- 7 Pin Receptacle with Shorting Cap and 3 Pin Photocell [Included]
- Screw-In Bi-level Occupancy/Daylight Harvesting Sensor [Option]

EPA Rating

- 80W/120W/150W [1.62ft²]

Lumen Output

- 80W: 12,391lm
- 120W: 17,313lm
- 150W: 20,453lm

Finish

- Dark Bronze

Optical

- Distribution Type Included In Box:
 - Type III [Installed]
 - Type IV
 - Type V

Installation/Mounting

- Slipfitter [Installed] [KI]
- Adjustable Pole Arm Mount [Installed][KII]

Warranty

- 5 Year Warranty
See warranty documentation for more information.



ORDERING INFORMATION

EXAMPLE: ALPE2-S-KI

| Package | Wattage | CCT | Distribution | Input Voltage | Finish | Mount | Controls |
|-----------------------------------|---------------|-------------------|---------------------------|---------------|-------------|--|--|
| <input type="radio"/> ALPE2-S-KI | 80W/120W/150W | 3000K/4000K/5000K | Type III, Type IV, Type V | 120-277V | Dark Bronze | Slipfitter | 7 Pin Receptacle With Shorting Cap and \ 3 Pin Photocell |
| <input type="radio"/> ALPE2-S-KII | | | | | | Adjustable Pole Arm Mount [Round and Square Poles] | |

Note: CCT and Wattage are Selectable and that the Distribution is included.

Accessories (Sold Separately)

- ALPE2-S-RLS (Reversible Light Shield [80W~150W])
- D4 (Screw-in Bi-level Occupancy/Daylight Harvesting Sensor)
- RC-02 (Remote Commissioning Tool)

TECHNICAL DETAIL

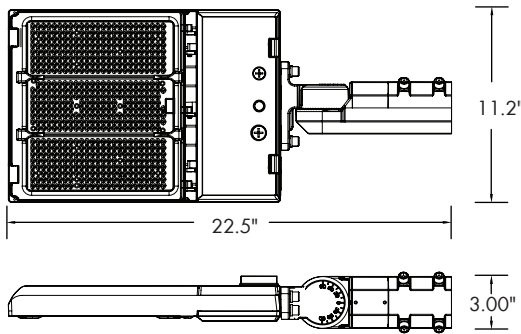

| Wattage | 3000K | 4000K | 5000K |
|---------|---------|---------|---------|
| 80W | 125lm/W | 140lm/W | 150lm/W |
| 120W | 125lm/W | 140lm/W | 150lm/W |
| 150W | 125lm/W | 140lm/W | 150lm/W |

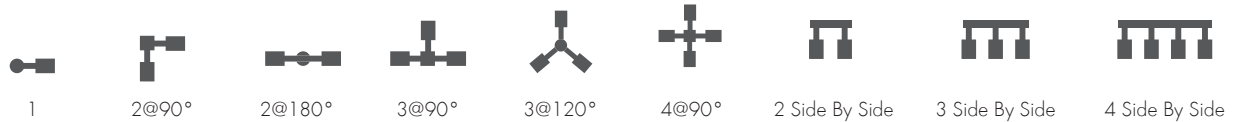

Configuration

| | 1 | 2@90° | 2@180° | 3@90° | 3@120° | 4@90° | 2 Side By Side | 3 Side By Side | 4 Side By Side |
|--------------|-------|-------|--------|-------|--------|-------|----------------|----------------|----------------|
| EPA (ft²) | 0.37 | 0.63 | 0.73 | 1.004 | 1.11 | 1.004 | 0.451 | 0.621 | 0.901 |
| Weight (lb.) | 11.66 | 23.32 | 23.32 | 34.98 | 34.98 | 46.64 | 23.32 | 34.98 | 46.64 |

PERFORMANCE TABLE

Lumen Output

Lumen value are from photometric test performed in accordance with IESNA LM-70-08. Data is considered to be representative of the configurations shown, within the tolerances allowed by Lighting Facts Contact factory for performance data on any configurations not shown here.

Performance Data:

| System Watts | Dist. Type | 3000K | | | | 4000K | | | | 5000K | | | |
|--------------|------------|--------|---|---|---|--------|---|---|---|--------|---|---|---|
| | | Lumens | B | U | G | Lumens | B | U | G | Lumens | B | U | G |
| 80W | 3 | 11543 | 3 | 0 | 3 | 12386 | 3 | 0 | 3 | 12229 | 3 | 0 | 3 |
| | 4 | 11488 | 3 | 0 | 3 | 12344 | 3 | 0 | 3 | 12213 | 3 | 0 | 3 |
| | 5 | 11778 | 3 | 0 | 2 | 12709 | 4 | 0 | 2 | 12540 | 4 | 0 | 2 |
| 120W | 3 | 17081 | 3 | 0 | 3 | 18964 | 3 | 0 | 3 | 16720 | 3 | 0 | 3 |
| | 4 | 17037 | 3 | 0 | 3 | 18912 | 3 | 0 | 3 | 16770 | 3 | 0 | 3 |
| | 5 | 17572 | 4 | 0 | 2 | 19529 | 4 | 0 | 2 | 17085 | 4 | 0 | 2 |
| 150W | 3 | 18460 | 3 | 0 | 3 | 20874 | 4 | 0 | 4 | 19809 | 3 | 0 | 3 |
| | 4 | 18375 | 3 | 0 | 3 | 20539 | 3 | 0 | 3 | 19538 | 3 | 0 | 3 |
| | 5 | 18844 | 4 | 0 | 2 | 20994 | 4 | 0 | 2 | 19528 | 4 | 0 | 2 |

ACCESSORIES

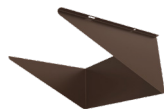

Reversible Light Shield
[Sold Separately]
[ALPE2-S-RLS]



**Screw-In Bi-Level
Occupancy/Daylight
Harvesting Sensor**
[Sold Separately]
[D4]



**Remote
Commissioning
Tool**
[Sold Separately]
[RC-02]

| | |
|---------------|--|
| Date: | |
| Project Name: | |
| SKU #: | |

ALP E2™ SP M

Adjustable Area & Site Light - Stocking Package



INCLUDED WITH ALP™ E2 IN STOCKING PACKAGE



Three Optic Lenses Included in Box:
Type III (Installed)
Type IV & Type V

APPLICATIONS

Commercial Parking Lots, Pedestrian Pathways, Street Lighting, Site and Recreational Sports

FEATURES

Construction

- Rugged Die-cast Aluminum Housing

Electrical & Technical

- Input Voltage: 120-277V
- Input Frequency: 50/60Hz
- Projected Life: L70 > 100,000 hrs
- PF: >0.9
- CRI: >80
- THD: <20%
- Adjustable Lumen Output
- CCT Selectable: 3000K/4000K/5000K
- Operating Temp.: -40°F ~ 113°F
- IP Rating: IP65 Fixture Enclosure
- IP Rating: IK08
- Surge Protection: 10kV [Included]
- AUX Power 12V [Included]

Controls

- 0-10V Dimming [Standard]
- 7 Pin Receptacle with Shorting Cap and 3 Pin Photocell [Included]
- Screw-In Bi-level Occupancy/Daylight Harvesting Sensor [Option]

EPA Rating

- 200W/240W/300W [2.47ft²]

Lumen Output

- 200W: 31,581lm
- 240W: 37,293lm
- 300W: 42,419lm

Finish

- Dark Bronze

Optical

- Distribution Type Included In Box:
 - Type III [Installed]
 - Type IV
 - Type V

Installation/Mounting

- Slipfitter [Installed] [KI]
- Adjustable Pole Arm Mount [Installed][KII]

Warranty

- 5 Year Warranty
See warranty documentation for more information.



ORDERING INFORMATION

EXAMPLE: ALPE2-M-KI

| Package | Wattage | CCT | Distribution | Input Voltage | Finish | Mount | Controls |
|-----------------------------------|----------------|-------------------|---------------------------|---------------|-------------|--|--|
| <input type="radio"/> ALPE2-M-KI | 200W/240W/300W | 3000K/4000K/5000K | Type III, Type IV, Type V | 120-277V | Dark Bronze | Slipfitter | 7 Pin Receptacle With Shorting Cap and \ 3 Pin Photocell |
| <input type="radio"/> ALPE2-M-KII | | | | | | Adjustable Pole Arm Mount [Round and Square Poles] | |

Note: CCT and Wattage are Selectable and that the Distribution is included.

Accessories (Sold Separately)

- ALPE2-M-RLS (Reversible Light Shield [200W~300W])
- D4 (Screw-in Bi-level Occupancy/Daylight Harvesting Sensor)
- RC-02 (Remote Commissioning Tool)

TECHNICAL DETAIL

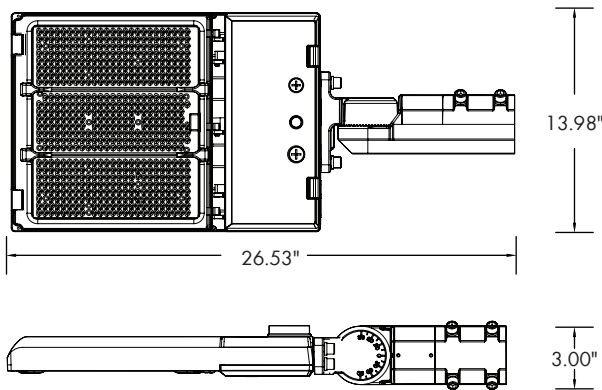

| Wattage | 3000K | 4000K | 5000K |
|---------|---------|---------|---------|
| 200W | 125lm/W | 140lm/W | 150lm/W |
| 240W | 125lm/W | 140lm/W | 150lm/W |
| 300W | 125lm/W | 140lm/W | 150lm/W |

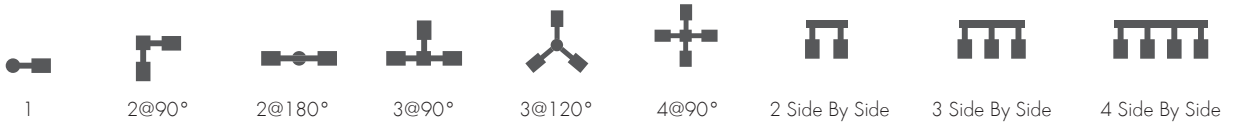

Configuration

| | 1 | 2@90° | 2@180° | 3@90° | 3@120° | 4@90° | 2 Side By Side | 3 Side By Side | 4 Side By Side |
|--------------|-------|-------|--------|-------|--------|-------|----------------|----------------|----------------|
| EPA (ft²) | 0.44 | 0.754 | 0.867 | 1.194 | 1.320 | 1.194 | 0.536 | 0.804 | 1.072 |
| Weight (lb.) | 15.07 | 30.14 | 30.14 | 45.21 | 45.21 | 60.28 | 30.14 | 45.21 | 60.28 |

PERFORMANCE TABLE

Lumen Output

Lumen value are from photometric test performed in accordance with IESNA LM-70-08. Data is considered to be representative of the configurations shown, within the tolerances allowed by Lighting Facts Contact factory for performance data on any configurations not shown here.

Performance Data:

| System Watts | Dist. Type | 3000K | | | | 4000K | | | | 5000K | | | |
|--------------|------------|--------|---|---|---|--------|---|---|---|--------|---|---|---|
| | | Lumens | B | U | G | Lumens | B | U | G | Lumens | B | U | G |
| 200W | 3 | 28318 | 4 | 0 | 3 | 30979 | 4 | 0 | 3 | 30028 | 4 | 0 | 4 |
| | 4 | 28913 | 4 | 0 | 3 | 31387 | 4 | 0 | 3 | 30719 | 4 | 0 | 4 |
| | 5 | 28845 | 4 | 0 | 3 | 31581 | 5 | 0 | 3 | 30258 | 5 | 0 | 5 |
| 240W | 3 | 32931 | 4 | 0 | 3 | 36572 | 4 | 0 | 4 | 34981 | 4 | 0 | 4 |
| | 4 | 33297 | 4 | 0 | 3 | 37110 | 4 | 0 | 3 | 35657 | 4 | 0 | 4 |
| | 5 | 33428 | 5 | 0 | 3 | 37293 | 5 | 0 | 3 | 35347 | 5 | 0 | 5 |
| 300W | 3 | 36954 | 4 | 0 | 4 | 41451 | 5 | 0 | 4 | 39458 | 4 | 0 | 4 |
| | 4 | 37545 | 5 | 0 | 3 | 41937 | 5 | 0 | 4 | 40200 | 4 | 0 | 5 |
| | 5 | 37609 | 5 | 0 | 3 | 42419 | 5 | 0 | 3 | 40276 | 5 | 0 | 5 |

ACCESSORIES

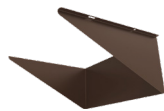

Reversible Light Shield
[Sold Separately]
[ALPE2-M-RLS]



**Screw-In Bi-Level
Occupancy/Daylight
Harvesting Sensor**
[Sold Separately]
[D4]



**Remote
Commissioning
Tool**
[Sold Separately]
[RC-02]

STRAIGHT ROUND STEEL POLES: 3", 4" ,5" Diameter

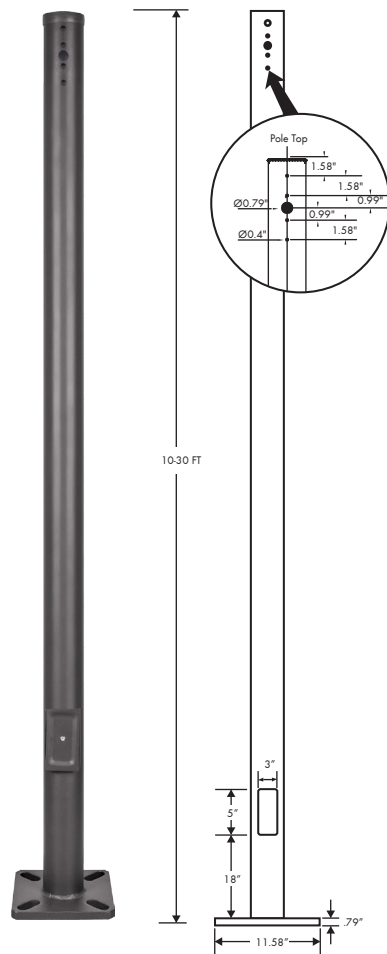

APPLICATIONS

Retail Centers, Industrial Parks, Schools, Universities, Public Transit, Airports, Office Buildings, and Medical Facilities

FEATURES

Specifications

Conforms to ASTM-A 500 Grade B: Minimum Yield Strength of 46,000 PSI. Pole Height Range From 10' to 30': Usage case is based on luminaire applications.

Finish

Textured architectural bronze powder coat finish: Baked to ensure maximum paint adhesion, hardness, and durability.

Anchor Bolts

Anchor bolts are included, sized based on pole data chart for the selected pole size.

Base Cover

Poles are provided with two -piece formed steel base cover that is easily assembled and fitted over the pole base.

Pole Height

Shown below in ordering matrix are the available standard pole height. Usage is based on selected luminaire application.

Mounting Options

Standard length poles include 2 3/8" O.D. tenon, side drilled 2@180°, polycarbonate top cover and hole plugs for unused drilling locations.

Our standard equipment is to make a top adapter with 2.5 inches. There is no opening on the top of the light pole. If ARM installation is needed, the top adapter shall be removed and holes shall be opened on the wall of the light pole. Finally, seal the top with a plastic rain cover.

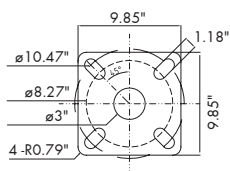

3" Flange

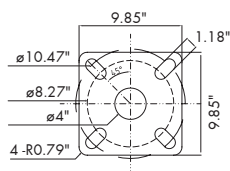

4" Flange

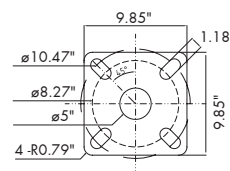

5" Flange

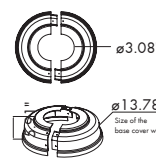

3" Flange
Base Cover

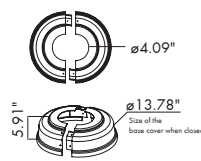

4" Flange
Base Cover

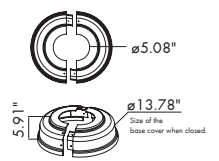

5" Flange
Base Cover

ORDERING INFORMATION

| Brand | Product | Height | Size | Wall Thickness | Finish |
|-------|----------------------|---|----------------------------|----------------|-----------------|
| TGS | R (Round Steel Pole) | 10FT (3.0M) 15FT (4.6M) 20FT (6.1M) 25FT (7.6M) 30FT (9.1M) | 3 (3") 4 (4") 5 (5") | 11G (11 Gauge) | D (Dark Bronze) |

DIMENSIONS DATA

| SKU | Height | Wall Thickness | Size Diameter | Pole Weight | Bolt Projection | EPA 70 | EPA 80 | EPA 90 | EPA 100 | EPA 110 | EPA 120 |
|------------------|--------|----------------|---------------|-------------|-----------------|--------|--------|--------|---------|---------|---------|
| TGS-R10FT3-11G-D | 10' | 11 Gauge | ø3" | 46 lb. | 2.75" | 28.2 | 23.5 | 20.1 | 14.4 | 13.3 | 11.6 |
| TGS-R15FT4-11G-D | 15' | 11 Gauge | ø4" | 90 lb. | 2.75" | 18.2 | 15.5 | 13.5 | 11.5 | 9.9 | 7.4 |
| TGS-R20FT4-11G-D | 20' | 11 Gauge | ø4" | 117 lb. | 2.75" | 12.2 | 10.3 | 9.0 | 7.2 | 6.0 | 4.6 |
| TGS-R25FT4-11G-D | 25' | 11 Gauge | ø4" | 139 lb. | 2.75" | 11.9 | 8.9 | 7.7 | 6.1 | 5.6 | 4.2 |
| TGS-R30FT5-11G-D | 30' | 11 Gauge | ø5" | 180 lb. | 2.75" | 9.2 | 7.4 | 6.1 | 5.8 | 4.8 | 3.2 |

National Wind Velocity Map

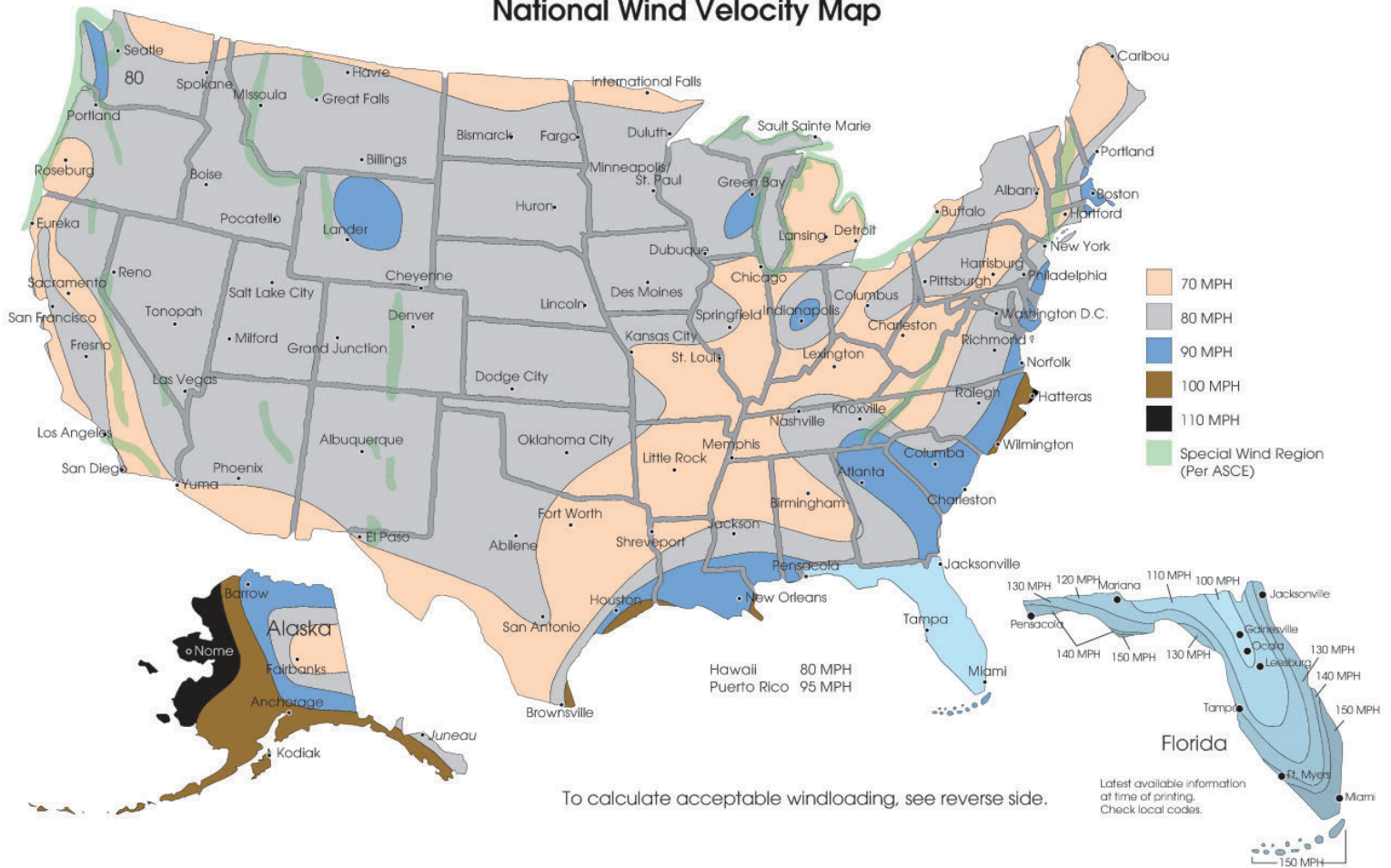

FIXTURE CONFIGURATIONS

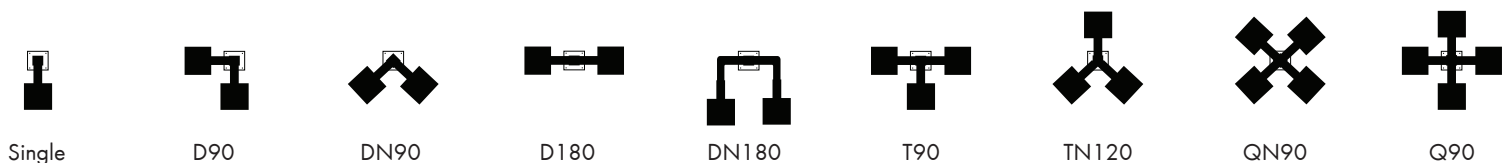

ACCESSORIES



3" Base Cover
No.: TGS-IBR3-D
Finish: Dark Bronze

The 3" Installation of base cover is used to protect the base after fixing the lamp pole, so that the lamp pole base is not damaged, thereby increasing the service life of the lamp pole.



4" Base Cover
No.: TGS-IBR4-D
Finish: Dark Bronze

The 4" Installation of base cover is used to protect the base after fixing the lamp pole, so that the lamp pole base is not damaged, thereby increasing the service life of the lamp pole.



5" Base Cover
No.: TGS-IBR5-D
Finish: Dark Bronze

The 5" Installation of base cover is used to protect the base after fixing the lamp pole, so that the lamp pole base is not damaged, thereby increasing the service life of the lamp pole.

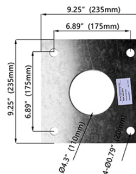

Screw Positioning Plate
No.: TGS-SPP235

This is a screw rod positioning plate. After the screw rod of the lamp rod base is fixed underground, the positioning plate is fixed with the screw rod to prevent the screw rod from deviation. Finally, the lamp rod is locked.

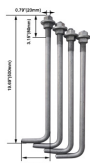

Base Mounting Screw
No.: TGS-BMS-S
Finish: Silver

Before installing the lamp pole, the installation hook should be buried underground and fixed by cement. After fixing, the lamp pole should be fixed by locking screw and base installed.

INSTALLATION

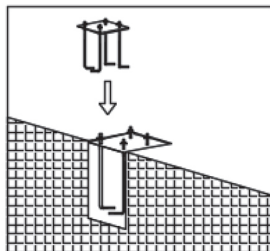

1. Dig a hole in the installation position of the lamp pole. Fixed four fastener fittings according to the hole position of lamp pole and poured with cement concrete. (as shown in the figure)

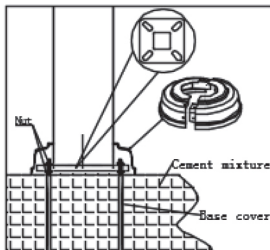

2. Install 4 screws onto the stick and adjust to same water level, then place the square plate and screw tightly. Install the cover at the bottom of pole. (as shown in the figure)

Foundation reference specification

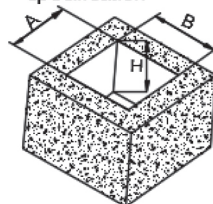

| Specifications | L | W | H |
|----------------|---------------|---------------|---------------|
| 10-15FT | 19.69"(500mm) | 19.69"(500mm) | 23.62"(600mm) |
| 20-25FT | 23.62"(600mm) | 23.62"(600mm) | 27.56"(700mm) |
| 30FT | 27.56"(700mm) | 27.56"(700mm) | 27.56"(700mm) |

3"X5" HAND HOLE COVER

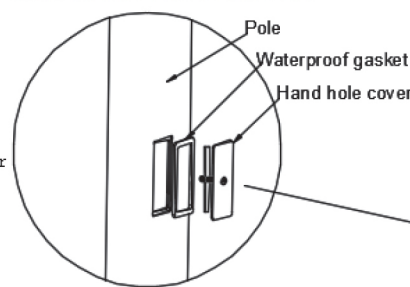

ANCHORAGE GUIDE

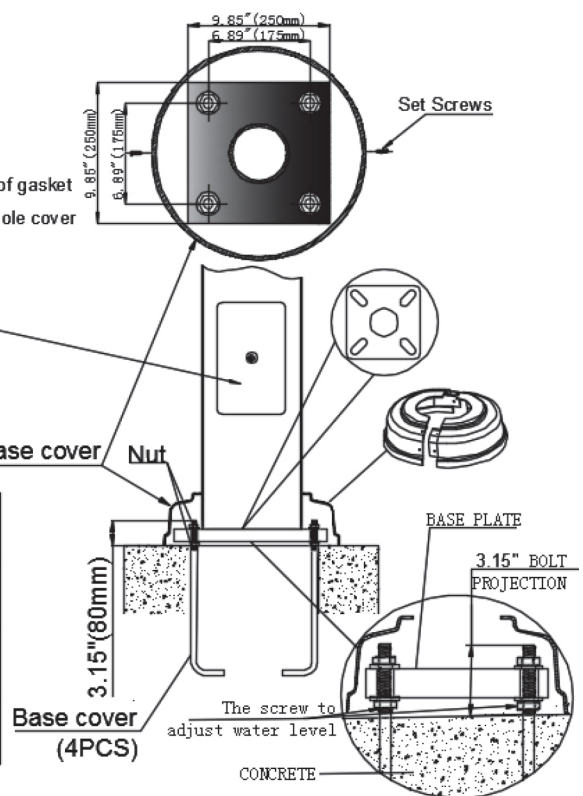

STRAIGHT SQUARE STEEL POLES: 4" (4"x4"), 5" (5"x5")

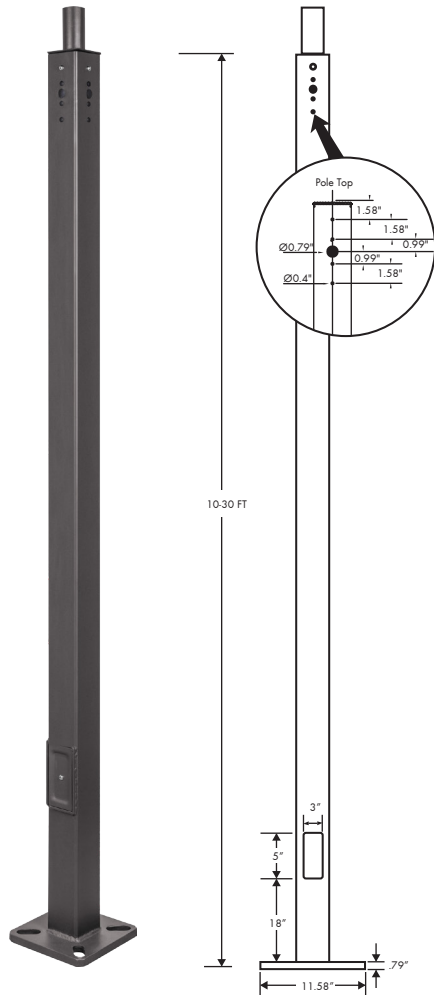

APPLICATIONS

Retail Centers, Industrial Parks, Schools, Universities, Public Transit, Airports, Office Buildings, and Medical Facilities

FEATURES

Specifications

Conforms to ASTM-A 500 Grade B: Minimum Yield Strength of 46,000 PSI. Pole Height Range From 10' to 30': Usage case is based on luminaire applications.

Finish

Textured architectural bronze powder coat finish: Baked to ensure maximum paint adhesion, hardness, and durability.

Anchor Bolts

Anchor bolts are included, sized based on pole data chart for the selected pole size.

Base Cover

Poles are provided with two-piece formed steel base cover that is easily assembled and fitted over the pole base.

Pole Height

Shown below in ordering matrix are the available standard pole height. Usage is based on selected luminaire application.

Mounting Options

Standard Poles Include 2 3/8" OD Tenon, Side Drilled 4@90 Degrees, Polycarbonate Top Cover and Hole Plugs for Unused Drilling Locations.

Our standard equipment is to make a top adapter with 2.5 inches. There is no opening on the top of the light pole. If ARM installation is needed, the top adapter shall be removed and holes shall be opened on the wall of the light pole. Finally, seal the top with a plastic rain cover.

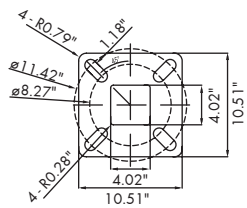

4" Flange

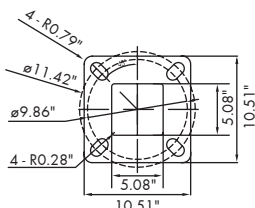

5" Flange

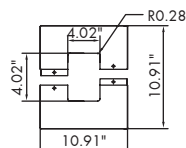

4" Flange Base Cover

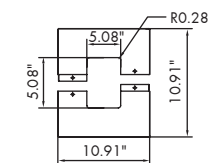

5" Flange Base Cover

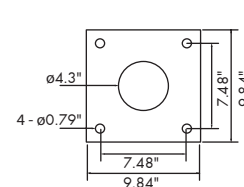

Anchor Positioning Plate

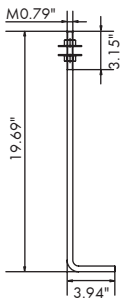

Anchor Bolt

ORDERING INFORMATION

| Brand | Height | Size | Wall Thickness | Finish | Mounting |
|-------|---|------------------------|----------------|-----------------|------------------|
| TGS | 10FT (3.0M) 15FT (4.6M) 20FT (6.1M) 25FT (7.6M) 30FT (9.1M) | 4 (4"x4") 5 (5"x5") | 11G (11 Gauge) | D (Dark Bronze) | T (2.5" Adapter) |

DIMENSIONS DATA

| SKU | Height | Wall Thickness | Size | Base | Bolt Circle | Bolt Projection | Bolt Size | Pole Weight | EPA 70 | EPA 80 | EPA 90 | EPA 100 | EPA 110 | EPA 120 |
|-------------------|--------|----------------|-------|------|-------------|-----------------|-----------|-------------|--------|--------|--------|---------|---------|---------|
| TGS-10FT4-11G-D-T | 10' | 11 Gauge | 4"x4" | 11" | 8" - 10" | 2.75" | ¾"x17"x3" | 88 lb. | 25.2 | 20.5 | 17.1 | 11.4 | 10.3 | 9.6 |
| TGS-15FT4-11G-D-T | 15' | 11 Gauge | 4"x4" | 11" | 8" - 10" | 2.75" | ¾"x17"x3" | 117 | 15.2 | 12.5 | 10.1 | 8.5 | 6.9 | 5.4 |
| TGS-20FT4-11G-D-T | 20' | 11 Gauge | 4"x4" | 11" | 8" - 10" | 2.75" | ¾"x17"x3" | 152 lb. | 9.2 | 7.3 | 6.0 | 4.2 | 3.0 | 1.6 |
| TGS-25FT4-11G-D-T | 25' | 11 Gauge | 4"x4" | 11" | 8" - 10" | 2.75" | ¾"x17"x3" | 190 lb. | 8.9 | 6.9 | 5.7 | 4.1 | 3.6 | 2.2 |
| TGS-30FT5-11G-D-T | 30' | 11 Gauge | 5"x5" | 11" | 10" - 12" | 3.375" | ¾"x17"x4" | 267 lb. | 7.2 | 5.4 | 4.1 | 3.8 | 2.8 | 1.2 |

National Wind Velocity Map

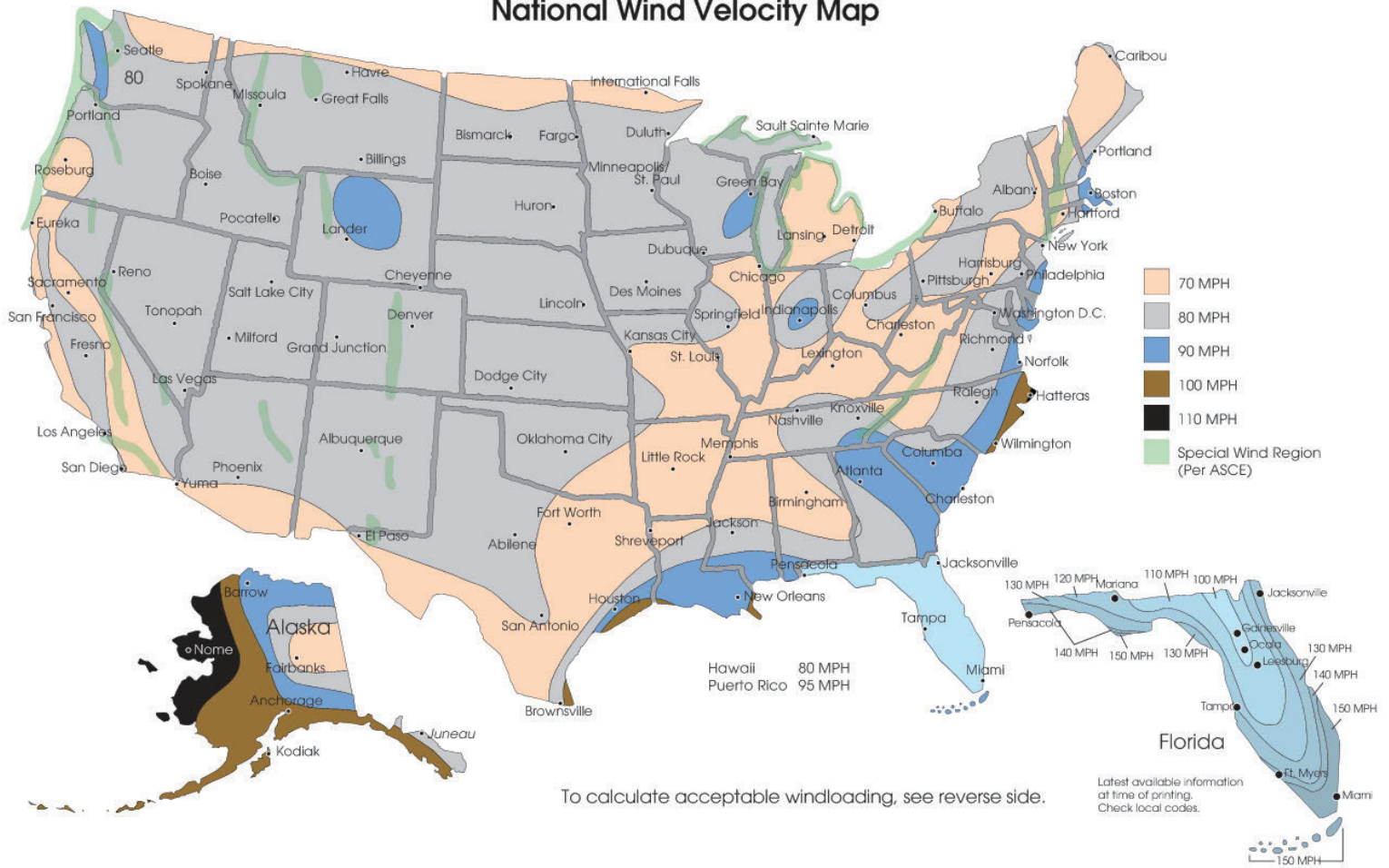

FIXTURE CONFIGURATIONS

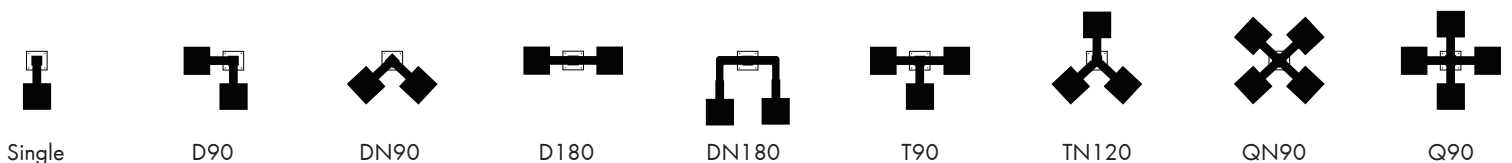

ACCESSORIES



4" Base Cover
No.: TGS-IBS4-D
Finish: Dark Bronze

The 4" Installation of base cover is used to protect the base after fixing the lamp pole, so that the lamp pole base is not damaged, thereby increasing the service life of the lamp pole.



Screw Positioning Plate
No.: TGS-SPP-D

This is a screw rod positioning plate. After the screw rod of the lamp rod base is fixed underground, the positioning plate is fixed with the screw rod to prevent the screw rod from deviation. Finally, the lamp rod is locked.



5" Base Cover
No.: TGS-IBS-D
Finish: Dark Bronze

The 5" Installation of base cover is used to protect the base after fixing the lamp pole, so that the lamp pole base is not damaged, thereby increasing the service life of the lamp pole.



Base Mounting Screw
No.: TGS-BMS-S
Finish: Silver

Before installing the lamp pole, the installation hook should be buried underground and fixed by cement. After fixing, the lamp pole should be fixed by locking screw and base installed.

INSTALLATION

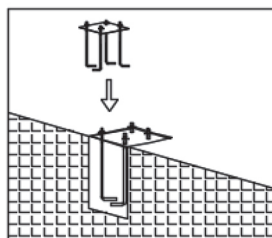

1. Dig a hole in the installation position of the lamp pole. Fixed four fastener fittings according to the hole position of lamp pole and poured with cement concrete. (as shown in the figure)

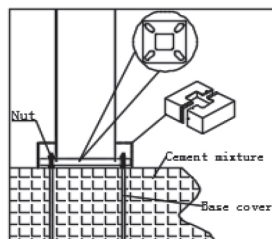

2. Install 4 screws onto the stick and adjust to same water level, then place the square plate and screw tightly. Install the cover at the bottom of pole. (as shown in the figure)

Foundation reference specification

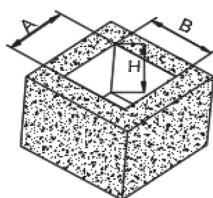

| Specifications | L | W | H |
|----------------|---------------|---------------|----------------|
| 10-15FT | 19.69"(500mm) | 19.69"(500mm) | 23.62"(600mm) |
| 20-25FT | 23.62"(600mm) | 23.62"(600mm) | 27.56"(700mm) |
| 30FT | 27.56"(700mm) | 27.56"(700mm) | 39.37"(1000mm) |

3"X5" HAND HOLE COVER

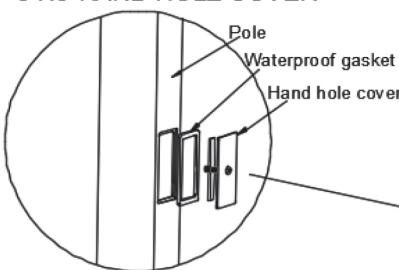

ANCHORAGE GUIDE

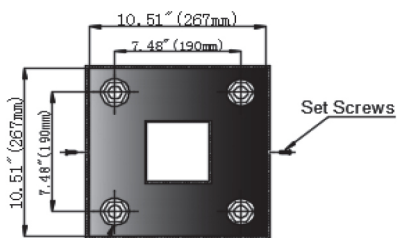

Flange base cover

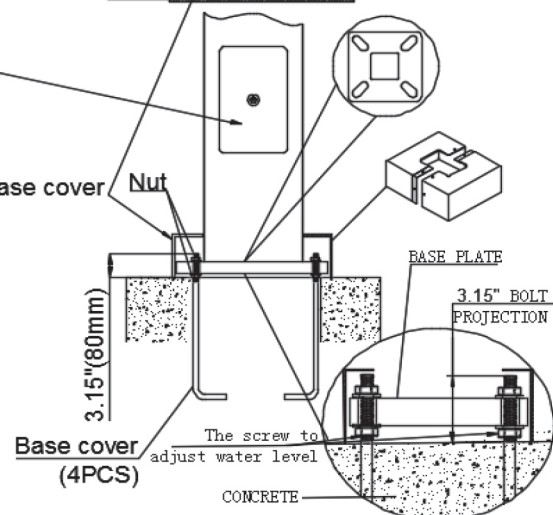

POLE ADAPTER

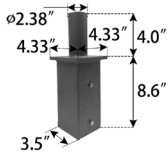

4" Square Pole Mount with 2-3/8" O.D Tenon
 No.: TGS-VTS4-D
 Finish: Dark Bronze
 Max EPA: 0.3
 USE: For use with square, non-tapered steel and aluminum poles. Furnished with four 5/16" hex head stainless-steel bolts. Vertical tenon measures 2-3/8" O.D., and is made of steel tubing. Fixtures mounted to this bracket can be adjusted both vertically and horizontally.

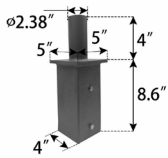

5" Square Pole Mount with 2-3/8" O.D Tenon
 No.: TGS-VTS5-D
 Finish: Dark Bronze
 Max EPA: 0.3
 USE: For use with square, non-tapered steel and aluminum poles. Furnished with four 5/16" hex head stainless-steel bolts. Vertical tenon measures 2-3/8" O.D., and is made of steel tubing. Fixtures mounted to this bracket can be adjusted both vertically and horizontally.

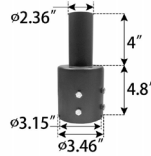

3" Round Pole Mount with 2-3/8" O.D Tenon
 No.: TGS-VT3-D
 Finish: Dark Bronze
 Max EPA: 0.3
 USE: For use with Round, non-tapered steel and aluminum poles. Furnished with three 3/8" hex head stainless-steel bolts. Vertical tenon measures 2-3/8" O.D., and is made of steel tubing. Fixtures mounted to this bracket can be adjusted both vertically and horizontally.

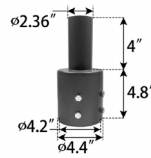

4" Round Pole Mount with 2-3/8" O.D Tenon
 No.: TGS-VT4-D
 Finish: Dark Bronze
 Max EPA: 0.3
 USE: For use with Round, non-tapered steel and aluminum poles. Furnished with three 3/8" hex head stainless-steel bolts. Vertical tenon measures 2-3/8" O.D., and is made of steel tubing. Fixtures mounted to this bracket can be adjusted both vertically and horizontally.



5" Round Pole Mount with 2-3/8" O.D Tenon
 No.: TGS-VT5-D
 Finish: Dark Bronze
 Max EPA: 0.3
 USE: For use with Round, non-tapered steel and aluminum poles. Furnished with three 3/8" hex head stainless-steel bolts. Vertical tenon measures 2-3/8" O.D., and is made of steel tubing. Fixtures mounted to this bracket can be adjusted both vertically and horizontally.

WALL BRACKET

• Attaches to any flat surface • Provides wiring access

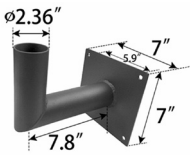

90° Wall Mount Bracket with 2-3/8" O.D. Tenon
 No.: TGS-ADP2.5-90-D
 Finish: Dark Bronze
 Max EPA: 0.6
 USE: The 90° wall mount bracket with 2-3/8" tenon attaches flood and area fixtures to almost any surface: wall, roof, or wood pole. Provides wiring access and a built-in 2-3/8" O.D. tenon to mount a fixture with our adjustable slip-fitter. Suggested 3/8" diameter bolts for mounting. Mounting holes are spaced 3-1/4" apart.

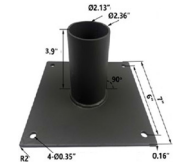

180° Wall Mount Bracket with 2-3/8" O.D. Tenon
 No.: TGS-ADP2.5-180L3.9-D
 Finish: Dark Bronze
 Max EPA: 0.5
 USE: The 180° wall mount bracket with 2-3/8" tenon attaches flood and area fixtures to almost any surface: wall, roof, or wood pole. Provides wiring access and a built-in 2-3/8" O.D. tenon to mount a fixture with our adjustable slip-fitter. Suggested 3/8" diameter bolts for mounting. Mounting holes are spaced 3-1/4" apart.



90° Wall Mount Bracket with 2-3/8" O.D. Tenon
 No.: TGS-ADP2.5-90H-D
 Finish: Dark Bronze
 Max EPA: 0.7
 USE: The 90° wall mount bracket with 2-3/8" tenon attaches flood and area fixture to almost any surface: wall, roof, or wood pole. Provides wiring access and a built-in 2-3/8" O.D. tenon to mount a fixture with our adjustable slip fitter. Suggested 3/8" diameter bolts for mounting. Mounting holes are spaced 3-1/4" apart.

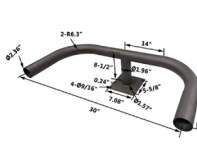

Double 180° Wall Mount Bracket with 2-3/8" O.D. Tenon
 No.: TGS-ADP2.5-180H-D
 Finish: Dark Bronze
 Max EPA: 1.4
 USE: The 180° wall mount bracket with 2-3/8" tenon attaches flood and area fixtures to almost any surface: wall, roof, or wood pole. Provides wiring access and a built-in 2-3/8" O.D. tenon to mount a fixture with our adjustable slip-fitter. Suggested 3/8" diameter bolts for mounting. Mounting holes are spaced 3-1/4" apart.

MID-POLE TENON BRACKET

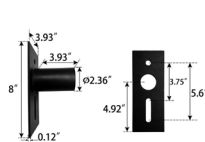

2-3/8" O.D. Horizontal Tenon Mid-Pole Bracket
 No.: TGS-ADP2.5-D
 Finish: Dark Bronze
 Max EPA: 0.3
 USE: 2-3/8" O.D. Horizontal Tenon Mid-Pole Bracket is designed to mount light fixture that is equipped with a adjustable slip-fitter onto a 2-3/8" O.D. horizontal tenon.

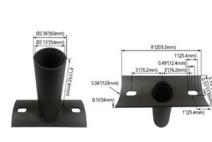

2-3/8" O.D. Horizontal Tenon Mid-Pole Bracket
 No.: TGS-ADP2.5-BAR5-D
 Finish: Dark Bronze
 Max EPA: 0.3
 USE: 2-3/8" O.D. Horizontal Tenon Mid-Pole Bracket is designed to mount light fixture that is equipped with a adjustable slip-fitter onto a 2-3/8" O.D. horizontal tenon.

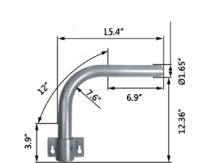

No.: TGS-WP-ARM-S
 Finish: Silver (Standard)
 USE: Wood pole arm bracket

ROUND EXTERNAL MOUNT HORIZONTAL TENON

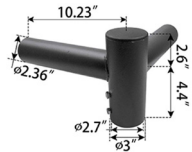

Double 90° Horizontal Tenon Adapter
 No.: TGS-SB2.5TW90-D
 Finish: Dark Bronze
 Max EPA: 0.6
 USE: The Bracket is designed to mount over 2-3/8" (60mm) O.D. vertical tenon. Two fixtures can be mounted to the Round External Mount Horizontal Tenon and adjusted horizontally.

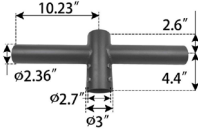

Double 180° Horizontal Tenon Adapter
 No.: TGS-SB2.5TW180-D
 Finish: Dark Bronze
 Max EPA: 0.4
 USE: The Bracket is designed to mount over 2-3/8" (60mm) O.D. vertical tenon. Two fixtures can be mounted to the Round External Mount Horizontal Tenon and adjusted horizontally.

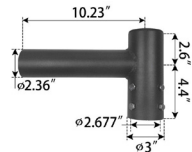

Single Spoke Bracket Tenon Adapter
 No.: TGS-SB2.5S-D
 Finish: Dark Bronze
 Max EPA: 0.4
 USE: The Bracket is designed to mount over 2-3/8" (60mm) O.D. vertical tenon. One fixture can be mounted to the Round External Mount Horizontal Tenon and adjusted horizontally.

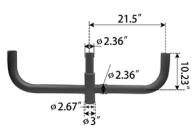

Triple 180° Horizontal Tenon Adapter
 No.: TGS-RB2.5TR180-D
 Finish: Dark Bronze
 Max EPA: 1.4
 USE: The Bracket is designed to mount over 2-3/8" (60mm) O.D. vertical tenon. Three fixtures can be mounted to the Round External Mount Horizontal Tenon and adjusted horizontally.

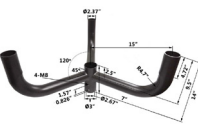

Triple 120° Horizontal Tenon Adapter
 No.: TGS-SB2.5TR120V-D
 Finish: Dark Bronze
 Max EPA: 1.5
 USE: The Bracket is designed to mount over 2-3/8" (60mm) O.D. vertical tenon. Three fixtures can be mounted to the Round External Mount Horizontal Tenon and adjusted horizontally.

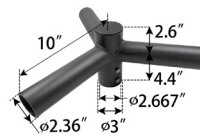

Triple 120° Horizontal Tenon Adapter
 No.: TGS-SB2.5TR120-D
 Finish: Dark Bronze
 Max EPA: 0.7
 USE: The Bracket is designed to mount over 2-3/8" (60mm) O.D. vertical tenon. Three fixtures can be mounted to the Round External Mount Horizontal Tenon and adjusted horizontally.

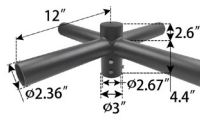

Quad 90° Horizontal Tenon Adapter
 No.: TGS-SB2.5QD90-D
 Finish: Dark Bronze
 Max EPA: 1.0
 USE: The Bracket is designed to mount over 2-3/8" (60mm) O.D. vertical tenon. Four fixtures can be mounted to the Round External Mount Horizontal Tenon and adjusted horizontally.

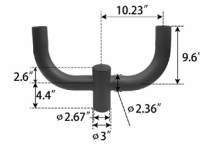

Double 180° Horizontal Tenon Adapter
 No.: TGS-RB2.5D180-D
 Finish: Dark Bronze
 Max EPA: 0.9
 USE: The Bracket is designed to mount over 2-3/8" (60mm) O.D. vertical tenon. Two fixtures can be mounted to the Round External Mount Horizontal Tenon and adjusted horizontally.

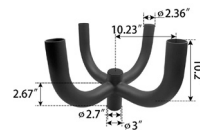

Quad 90° Horizontal Tenon Adapter
 No.: TGS-RB2.5QD90-D
 Finish: Dark Bronze
 Max EPA: 1.5
 USE: The Bracket is designed to mount over 2-3/8" (60mm) O.D. vertical tenon. Four fixtures can be mounted to the Round External Mount Horizontal Tenon and adjusted horizontally.

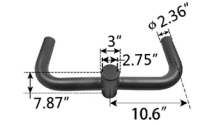

Double 180° Horizontal Tenon Adapter
 No.: TGS-RB2.5TR180H-D
 Finish: Dark Bronze
 Max EPA: 1.0
 USE: The Bracket is designed to mount over 2-3/8" (60mm) O.D. vertical tenon. Two fixtures can be mounted to the Round External Mount Horizontal Tenon and adjusted horizontally.



Square Tube Turn to Round Tenon Adapter
 No.: TGS-SADP-BAR-D
 Finish: Dark Bronze
 USE: Square tube light bar installation, with Arm installation of lamps.

ROUND EXTERNAL MOUNT HORIZONTAL TENON

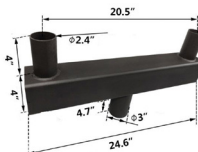

Low Profile Bullhorn with 2 Tenons
 No.: TGS-VTS4R-2T-D
 Finish: Dark Bronze
 Max EPA: 1.0
 Weight: 20 lbs.
 USE: The Bracket is designed to mount over 2-3/8" O.D. vertical tenon. Two fixtures can be mounted to the Round External Mount Horizontal Tenon and adjusted horizontally.

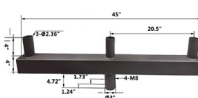

Low Profile Bullhorn with 3 Tenons
 NO. TGS-VTS4R-3T-D
 Finish: Dark Bronze
 MAX EPA: 1.6
 USE: The Bracket is designed to mount over 2-3/8" O.D. vertical tenon. Three fixtures can be mounted to the Round External Mount Horizontal Tenon and adjusted horizontally.

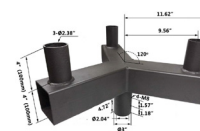

Triple 120° Horizontal Tenon Adapter
 No.: TGS-QT120-3T-D
 Finish: Dark Bronze
 Max EPA: 1.4
 USE: The Bracket is designed to mount over 2-3/8" (60mm) O.D. vertical tenon. Three fixtures can be mounted to the Round External Mount Horizontal Tenon and adjusted horizontally.



Quad 90° Horizontal Tenon Adapter
 No.: TGS-QT90-4T-D
 Finish: Dark Bronze
 Max EPA: 1.8
 USE: The Bracket is designed to mount over 2-3/8" (60mm) O.D. vertical tenon. Four fixtures can be mounted to the Round External Mount Horizontal Tenon and adjusted horizontally.